

Mix

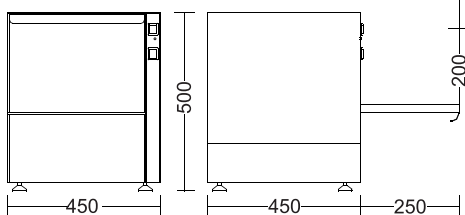

Top

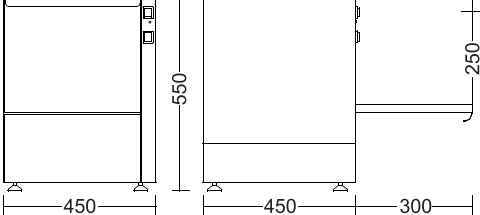

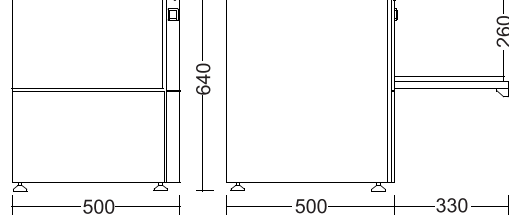

Ergon



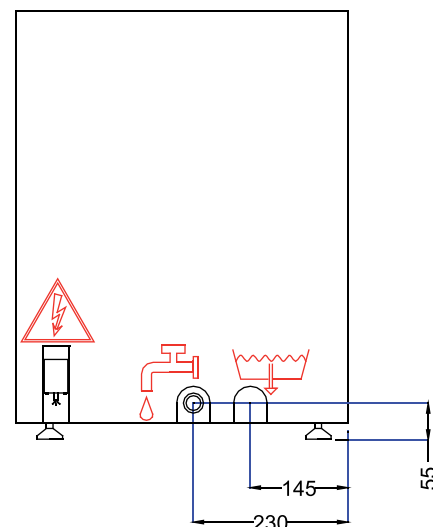
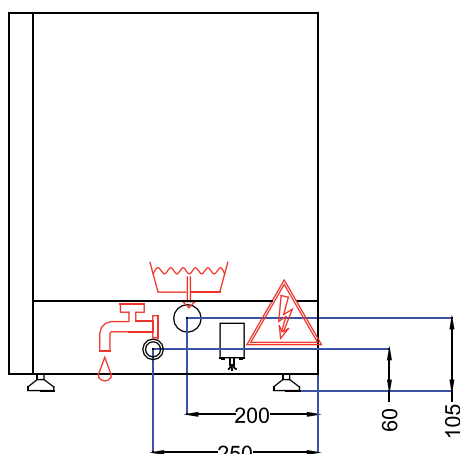
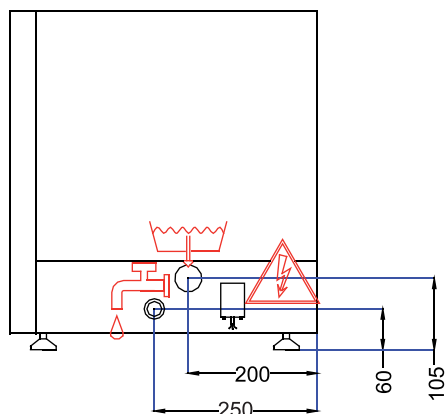

					MIX - TOP	ERGON
Ciclo lavaggio/risciacquo	Wash/rinse cycle	Spül-/Nachspüldauer	Durée du lavage/rinçage	Ciclo lavado/aclarado	sec.120"	sec.120"
Cesto	Rack	Korb	Panier	Cesto	mm □ 370x370	mm □ 400x400
Alimentazione elettrica	Electrical supply	Elektroanschluß	Tension d'alimentation	Alimentación eléctrica	230V ~ 50 Hz	230V ~ 50 Hz
Resistenza boiler	Boiler heating element	Boilerheizung	Résistance boiler	Resistencia boyler	W 2000	W 2000
Resistenza vasca	Tank heating element	Beckenheizung	Résistance de la cuve	Resistencia cuba	W 2000	W 2000
Elettropompa	Wash pump	Umwälzpumpe	Pompe de lavage	Electrobomba	Hp 0,20	Hp 0,20
Totale assorbimento	Total rating	Gesamtanschlußwert	Puissance de raccordement	Potencia total absorbida	W 2250	W 2250
Capacità boiler	Boiler capacity	Boilerinhalt	Capacité du boiler	Capacidad en boyler	lt 2	lt 4
Capacità vasca	Tank capacity	Tankinhalt	Capacité de la cuve	Capacidad en cuba	lt 12	lt 14
Consumo acqua a 3 bar	Water use at 3 bar	Wasserverbrauch bei 3 bar	Consommation eau a 3 bar	Consumo agua 3 bar	lt/ciclo 2	lt/ciclo 3
Pressione acqua alimentazione	Water supply pressure	Fließwasserdruck	Pression eau d'alimentation	Presión agua alimentación	bar min-max 3-5	bar min-max 3-5
Dosatore di detergente	Built-in detergent pump	Eingebaute Reinigerdosierung	Doseur de détergent incorporé	Dosificador de detergente	no	option
Depuratore incorporato	Built-in water softener	Eingebautem Entkalker	Adoucisseur incorporé	Descalcificador incorporado	no	option
Pompa di scarico	Drain pump	Abwasserpumpe	Pompe de relevage	Bomba de descarga	no	no
Cesto piatti 8 posti	Rack 8 plates	Korb für 8 Teller	Panier 8 assiettes	Cesto 8 platos	option	option
Caricamento automatico	Automatic filling	Automatische Wasserfüllung	Remplissage automatique	Llenado automatico		
Sicurezza porta	Door safety	Türsicherheitsschalter	Sécurité de porte	Seguridad puerta		
Risciacquo caldo	Hot rinse	Warme Nachspülung	Rinçage eau chaude	Aclarado caliente		
Dosatore di brillantante	Rinse-aid dispenser	Nachspülmitteldosiergerät	Doseur produit de rinçage	Dosificador del abrillantador		

Dotazione cesti:	Standard racks:	Korbausstattung:	Dotation paniers:	Dotacion cestos:
2 cesti bicchieri	2 baskets for glasses	2 Körbe glatt für Gläser	2 paniers verres	2 cestos vasos
1 inserto piattini	1 insert for saucers	1 Einsatz für Untertassen	1 support soucoupes	1 soporte platos de café
1 contenitore posate	1 cutlery insert	1 Besteckkorbchen	1 godet	1 cestillo cubiertos
1 tubo carico 3/4" gas	1 3/4" gas water supply hose	1 Wasserzulaufschlauch R 3/4"	1 tuyau d'alimentation eau de 3/4" gas	1 tubo carga 3/4" gas
1 tubo scarico Ø 30	1 30 mm Dia water drain hose	1 Abwasserschlauch Ø 30	1 tuyau de vidange Ø 30	1 tubo desague Ø 30



 Carico acqua 3/4" G. - Water supply hose 3/4" G. - Wasseranschluß 3/4" G. - Entrée d'eau 3/4" G. - Conexión alimentación 3/4"

 Scarico acqua Ø 30 - Water drain hose Ø 30 - Abwasseranschluß Ø 30 - Vidange eau Ø 30 - Conexión desague Ø 30

 Alimentazione elettrica - Electrical supply - Elektrischer Anschluß - Branchement électrique - Conexión eléctrica